

HAYER & BOECKER

Innovation and Quality for the
21st Century



HAYER valve-type bag filling machine with automatic bag applicator



HAYER FFS DELTA



Stationary HAYER INTEGRA valve-type bag filling machine



HAYER ROTOSEAL® system

PM 214 E 2632 1202 1 Fe

The machines and plants shown in this leaflet as well as the stated technical parameters are examples of customer-specific technical solutions. Therefore they are subject to modifications.

HAYER & BOECKER



Information

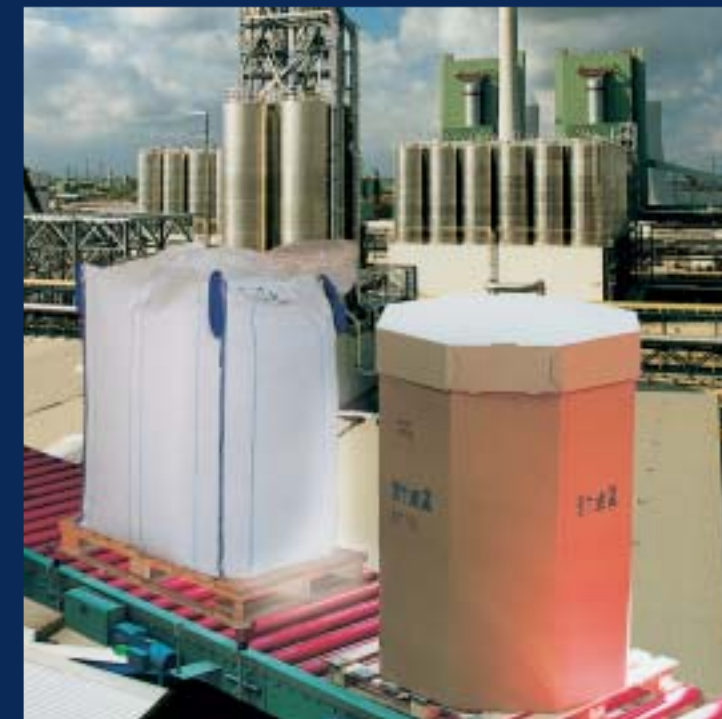

HAYER
Semi-bulk Filling
Technology

HAYER & BOECKER

P.O. Box 33 20 • D-59282 OELDE, Germany • Phone: +49-25 22-30 0 • Telefax: +49-25 22-3 04 03
E-Mail: haver@haverboecker.com • Internet: <http://www.haverboecker.com>

Affiliated Company USA: HAYER FILLING SYSTEMS, INC.
Phone: +1-770 760-11 30 • Telefax: +1-770 760-11 81
E-Mail: sales@haverusa.com • Internet: <http://www.haverusa.com>

Affiliated Company Brazil: HAYER & BOECKER Latinoamericana M&qs. Ltda.
Phone: +55-19-3879-9100 • Telefax: +55-19-3879-1410
E-Mail: haverhbl@haverbrasil.com.br • Internet: <http://www.haverbrasil.com>

Affiliated Company France: HAYER FRANCE S.A.R.L.
Phone: +33.01.39.11.80.80 • Telefax: +33.01.39.11.80.89
E-Mail: haver.hfp@wanadoo.fr

Semi-bulk containers

FIBC – Flexible intermediate bulk container



Stable Big-bags

HAYER & BOECKER have been producing filling and weighing systems for flexible packaging such as FIBCs, octabins, cartons and other semi-bulk packaging units for over 20 years. When compared to conventional bags or other small packages, these systems represent a cost effective alternative within the logistical supply chain for handling loose, bulk

material. HAYER technology is suitable for all applications involving filling and bagging of goods. Commercially available FIBCs with 1, 2 or 4 loops and a rigid filling spout or open top side are easily filled. Special big-bag design features such as interior stiffening for improving stability have been fully taken into account during the design phases of our filling systems.

In combination with a carrier frame, barrels and cartons may be filled using the same weighing system. For big-bags with PE interior inserts, the filling system is equipped with a bag inflation unit which expands the bag before filling starts. For this operation, systems using compressed air or blowers are available. Using modular configurations and proven

components, we deliver optimized individual solutions that fulfill specific technical needs, are economical and environmentally sound.

Filling system for FIBC with one loop



Big-bag filling and weighing system

FIBCs with one loop have penetrated the market, especially for large quantities of loose, bulk materials such as cement, fertilizers, etc. where high filling rates can be achieved using basic technology. For the most part, the technology involves bags that are filled, weighed and transported while hanging, and assuring bag stability for subsequent transport by a forklift.

Depending on material flow characteristics, filling rates of up to 40 Big-bags per hour are

possible. For filling, the spout is inserted into the bag opening. The bag loop is hooked to the suspension hook which in turn is connected to the suspension eyelet of the weigher load cell. Using a START button, the filling cycle starts and the product is simultaneously weighed. A cone valve regulates product feeding into the bag. After the filling ends, the filled bags are transported away from the filling station by the stacker and changeover suspension hooks assure continuous, uninterrupted production. Weighing and filling parameters are selected using the MEC II-20 electronic weigher. By using optional suspension frames, 2-point or 4-point FIBCs may be filled as well. Efficient filling and weighing systems that have robust, long lasting and precise construction are the results of our years of development work. These filling systems may be laid out in pairs for direct loading of trucks, or they may be stationed as mobile units under silos.

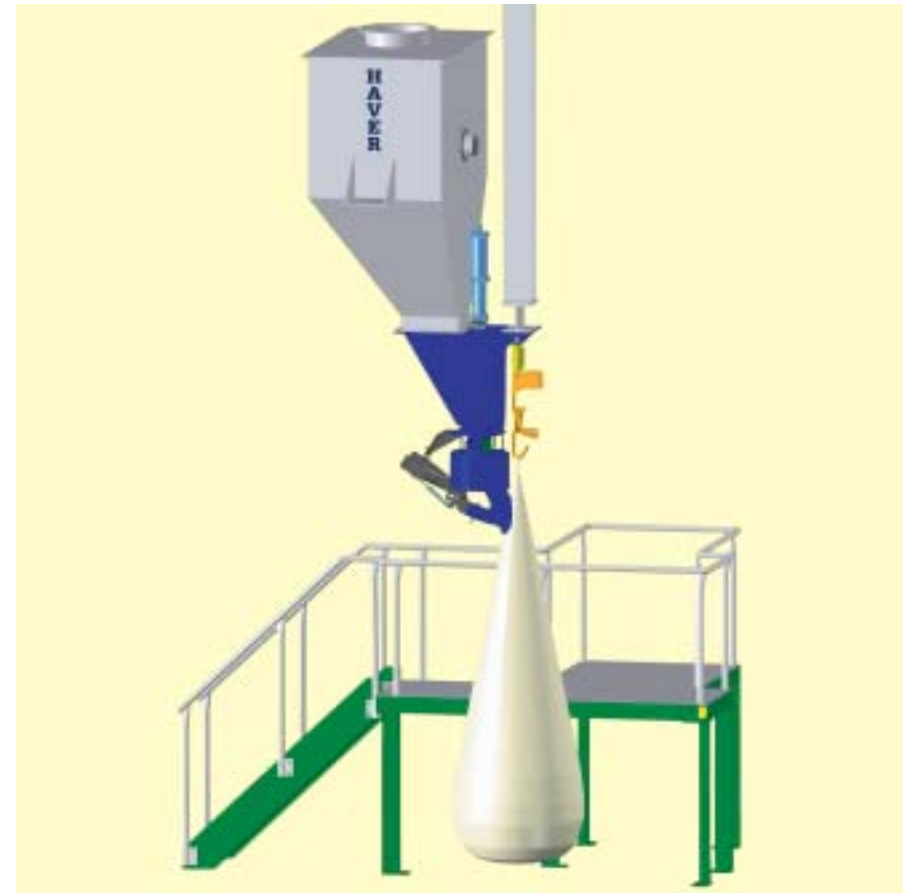

HAYER Big-bag weigher

Product compaction during filling

The decisive factors for optimum filling and FIBC stability are the appropriate air extraction rates and product compaction, as to the product's properties. These are the keys to HAVER's proven technology.

Powder type products, which are filled in a fluid state, are preferably removed of air by using a vacuum probe. For this operation, the vacuum probe is made of HAVER Poroplate® wire mesh and used according to the filling volume. The pore size of the vacuum probe is determined by the smallest grain diameter of the product (min. > 1 µm). Air extraction from the product occurs during coarse filling, or after filling and is programmable via the control unit.

Product compaction and reduction of the product

shear angle have been optimized for a wide variety of products by employing a HAVER vibration unit. Depending on the product's properties, an individual vibration system is selected. Agitation motors, controlled by a frequency inverter, allow selection of a frequency that best matches the product's properties. Depending on the product's flow characteristics, this assures the selection of the optimum compaction parameters.

All product-specific adjustment parameters are selected via the control panel.



Air extraction from the product using the HAVER Poroplate® vacuum probe

Photo left:
The vibration unit is integrated with the roller conveyor

High performance machines for powder-type, loose materials require systems that match the product. For filling rates of over 40 bags per hour, a filling system with two compaction units may be used. The product is compacted at the filling

station by a HAVER vibration table. For optimizing productivity, the filled but not yet fully compacted bag is then transported to a subsequent compaction station where a second vibration table further compacts the product. This results in fully compacted FIBC

filled bags, even at high filling speeds. The success of this system has been proven, especially when filling highly fluid, loose materials. The combination of vacuum air extraction and a vibration unit is also a proven system

configuration for achieving the highest possible filling speeds.

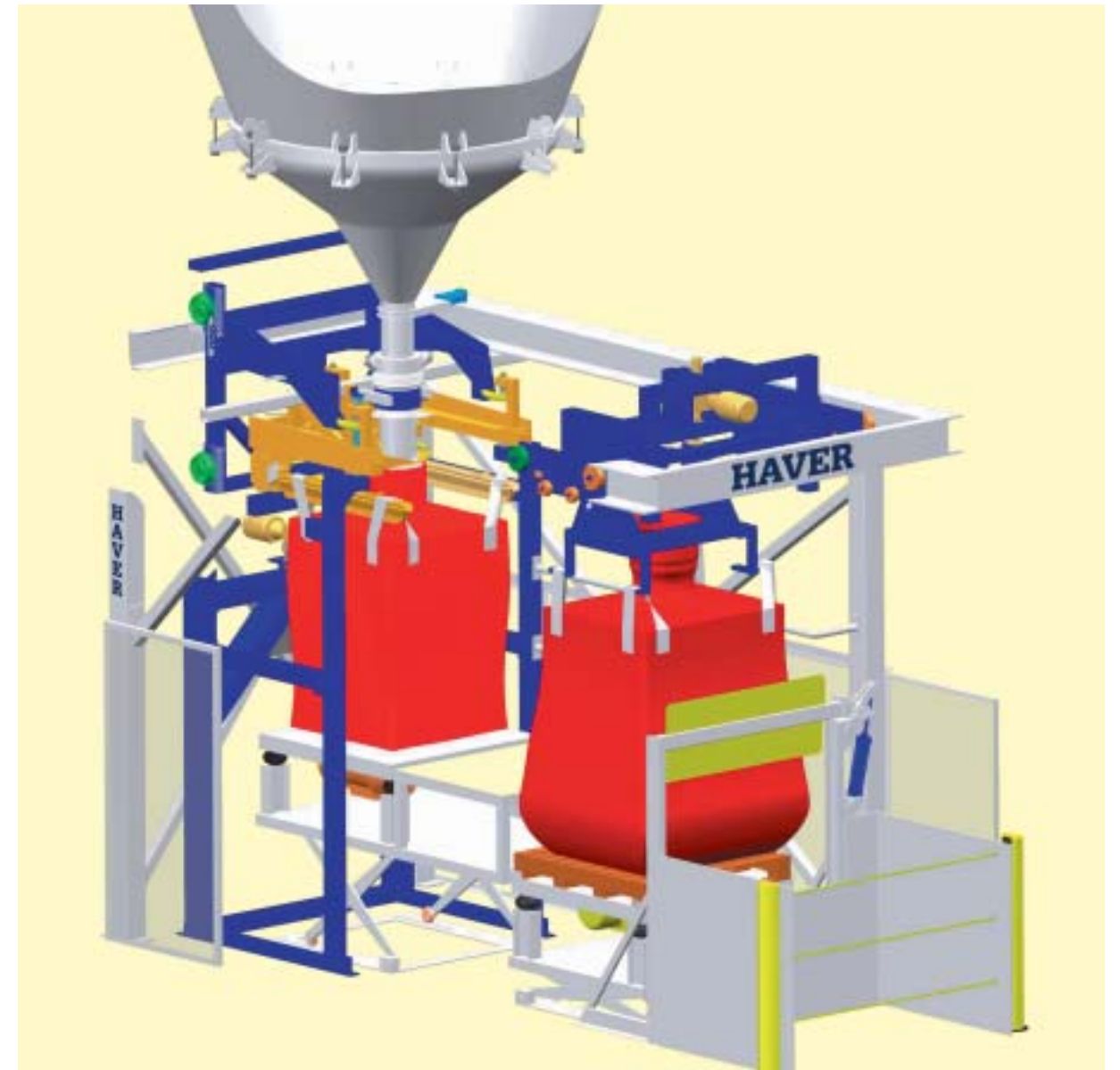

High performance filling station equipped with two vibration units.

HAYER product dosing and system components



1. Guide assembly



2. Operator's panel



3. Hoisting unit

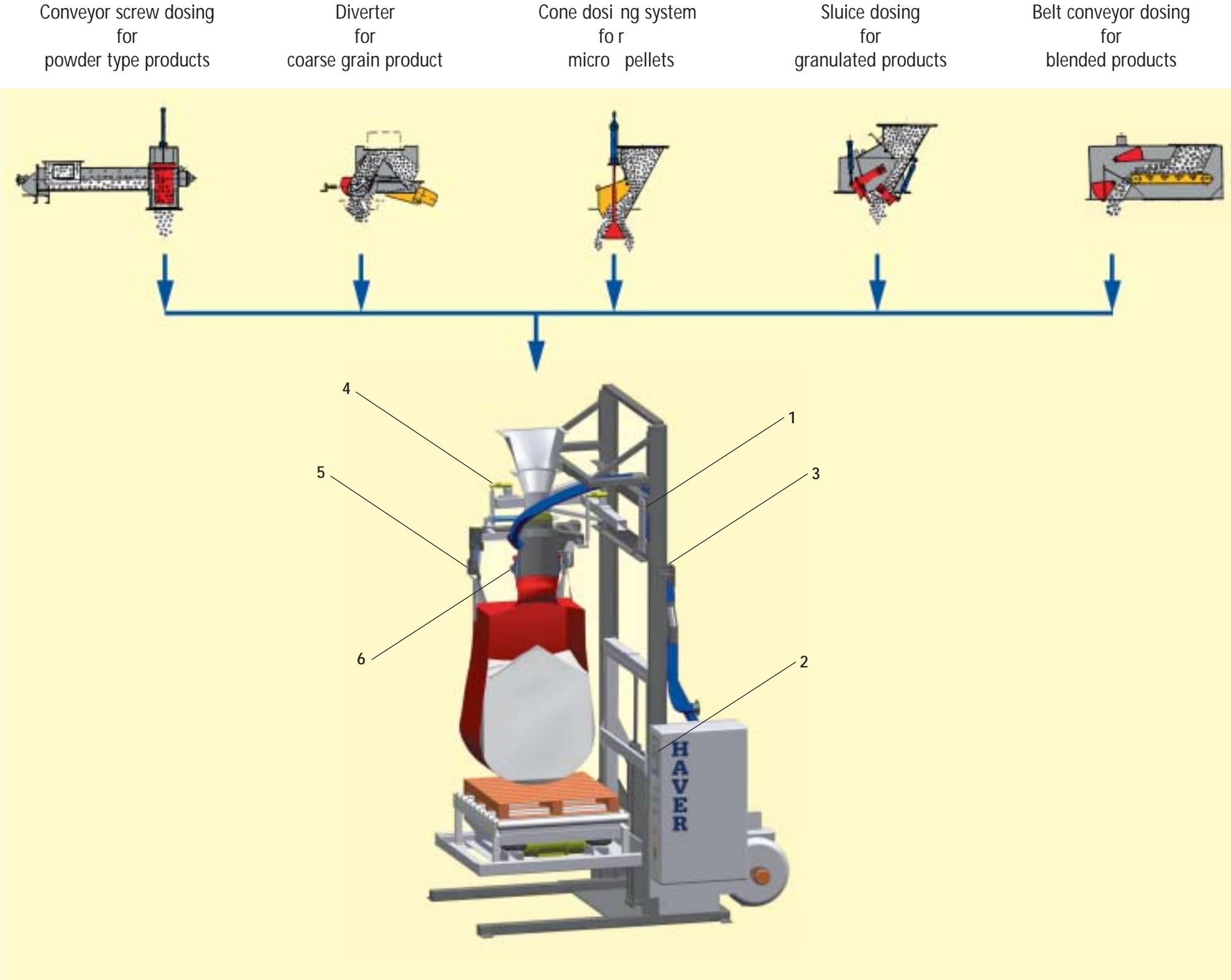

4. Weighing load cell



5. Pneumatically operated hook



6. Filling spout with an inflatable sleeve (option)

Operation

The wide variety of available FIBCs requires a variable filling head that can be optimally operated when filling bags of different sizes. The HAVER FIBC filling head has been optimized for easy operation. The rear hooks are swiveled in position by a pneumatic cylinder and is easily accessible by the operator. The filling station then swings over to the operator. Dust-free filling of the FIBC is assured by an inflatable sleeve and a counter-pressure ring installed at the filling spout.

The sturdy filling head is attached to 3 load cells, which are connected to the HAVER electronic weigher system and assure precision weighing – even for technically difficult, free flowing materials.

The HAVER FIBC filling system has proven itself to be a high performance, reliable filling system – even when operated in extremely dusty or aggressive environments.

Together with the BT 15 operator's terminal, the HAVER electronic weigher system fulfills all the requirements for easy, functionally appropriate operation of filling stations. All important functions and data are displayed online.

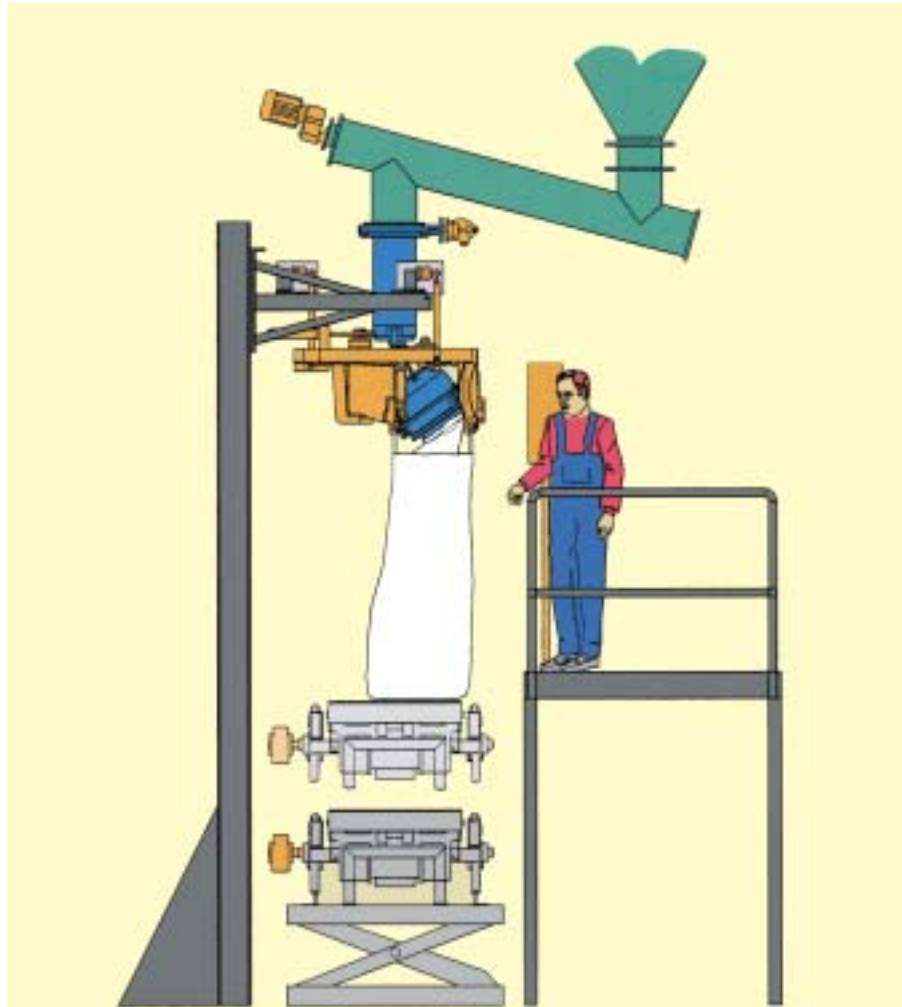

Diagram above:
Diagram of an FIBC filling station with an integrated vibration unit

Photo left:
Operator's terminal for the electronic weighing system and BT 15 operator's panel

Options

To avoid unwanted product leakage from the filling spout during bag exchanges, a filling spout closure unit may be installed as an option. After the filling step is completed, the closure unit tightly closes off the end of the spout. As a result, dirtying of bags from residual product spillage is eliminated. This closure unit is designed not to interfere with product flow during filling.

The HAVER FIBC filling head may be combined with an automatic bag closing unit. For closing of the bag after the filling operation, the filling head is decoupled from the compressed air system and, by rotating the filling spout, a so-called "tulip" is formed. The dust-free, wound bag may be then either manually or automatically closed using a metal clip. Except for hanging empty bags, this option assures a complete, functional process that takes place automatically.

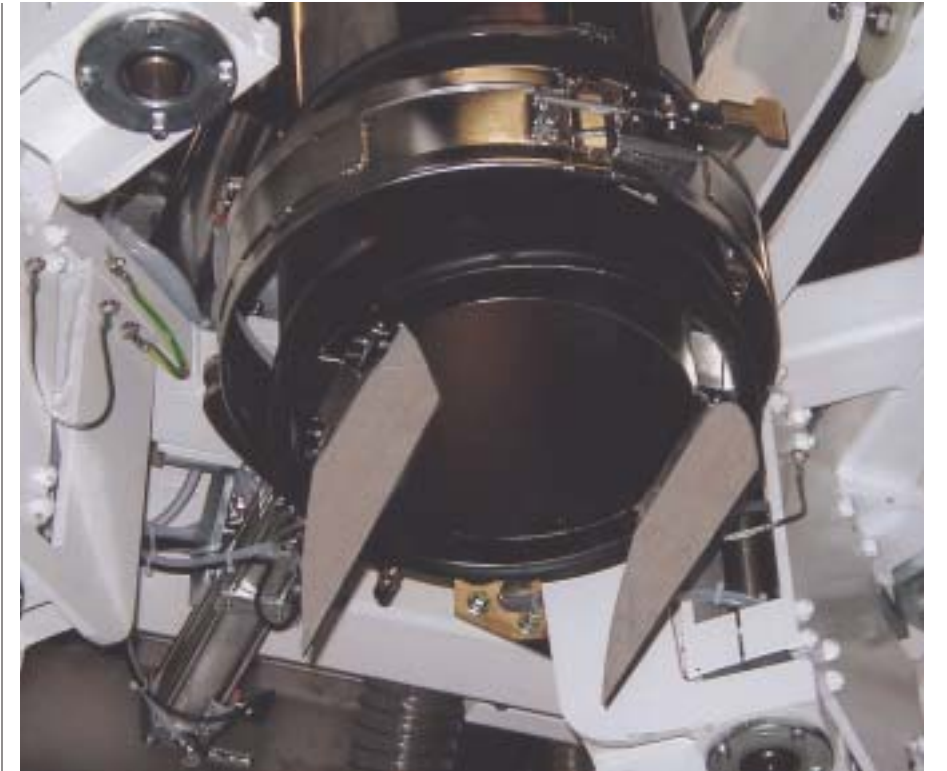

Filling spout closure unit

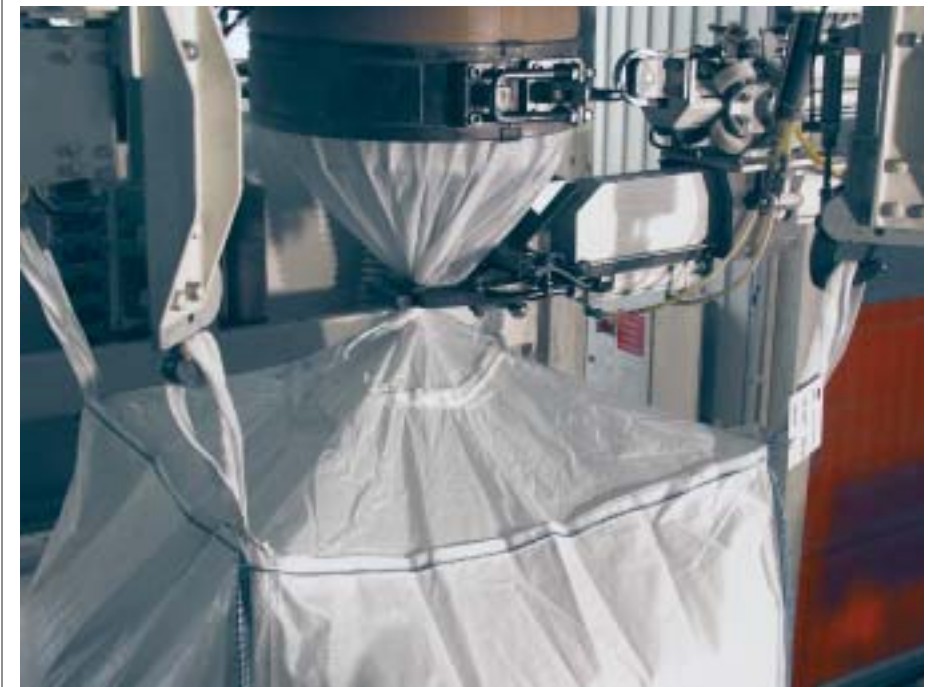

Big-bag closing unit

Pallet transport



A complete Big-bag filling system equipped with a pallet unitizer, roller system and filling station

Especially where high filling rates and the subsequent transport of the filled bags on pallets are foreseen, it makes sense to add a pallet transport system. Roller tracks and pallet unitizers are available for achieving this and are customized to meet specific filling requirements. If desired, a slip sheet applicator may be included as well.

If bags with smaller weights are to be stacked over each other, the roller tracks may be reversible and thereby allow, for example, 2 or even 3 bags to be automatically stacked under the filling head. Precisely controlled conveyor elements assure perfectly centered FIBC stacking.



Perfectly centered, double big-bag stacking

System variations

This HAVER supplied filling station, which is designed for octabins and FIBCs with a filling speed of maximum 40 bags per hour, is an example of technology that exactly fulfills the needs of a specific application. Together with a HAVER net weigher and an integrated HAVER vibration station, plastic granulate is optimally bagged and sealed.

The entire unit is built on wheels, is fully mobile and may be docked under any silo of choice. All product relevant data are transmitted via a radio communication system from a central control room. In addition, this filling station is equipped with an automatic water cleaning system that provides quick and easy cleaning during product changeovers.



Mobile semi-bulk filling station